

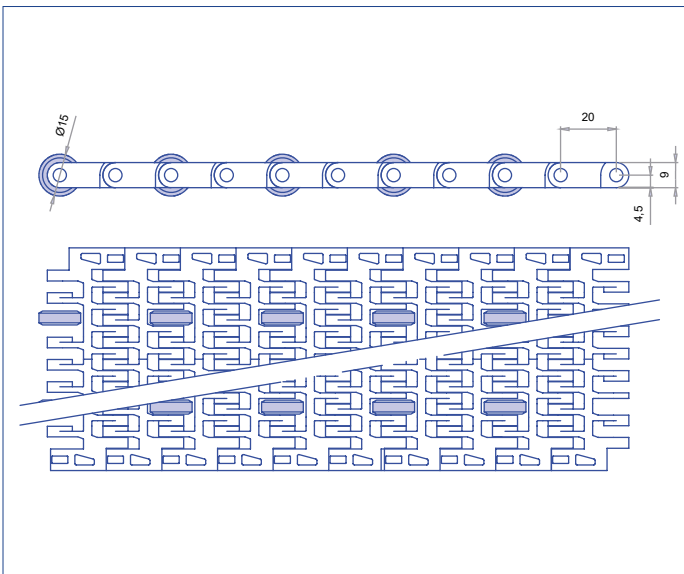





Series E20 Sliding Rollers



	Belt pitch	20 mm
	Belt width	Multiples of 8 mm
	Rod diameter	4,6 mm
	Drive system	Central
	Ø min direct rotation roller	26 mm
	Ø min reverse rotation roller	100 mm

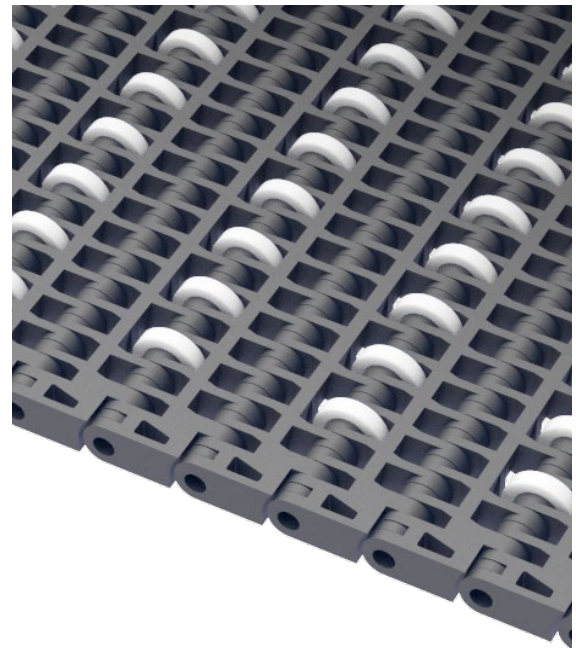

EUROBELT Series E20 with a pitch of 20 mm and widths in increments of 8 mm can adapt to almost every dimension. It is ideal for replacements which are complicated or having non-metric dimensions.

The traction is carried out in the central part of the modules; that is why it can be used as a bidirectional belt.

It enables transferences of product at high speeds with minimum turn diameters of about 30 mm.

Belt surface	Belt material	Rod material	Belt resistance (kg/m)	Belt weight (kg/m ²)	Temperature limit (C°)	Standard Colours ¹	Open Area + opening dimensions	Belt thickness	Retention system
Sliding Rollers	PP-Polypropylene	PP-Polypropylene	According to the width spacing. Consult.	Consult	+1 to +104	W - G - B	0%	Consult	Cap
	PE-Polyethylene	PE-Polyethylene		Consult	-50 to +65	B			
	POM -Acetal	PP-Polypropylene		Consult	+1 to +90	B			
		PE-Polyethylene		Consult	-40 to +65	B			

¹W = White G = Grey N = Natural B = Blue O = Black

Special qualities

	Sliding rollers width	Sliding rollers material	Sliding rollers diameter	Spaces between sliding rollers
Sliding rollers	4,9 mm	Acetal	15 mm	Multiples of 20 mm

Accessories **E20** Sprockets

We also have sprockets to be used with motor drum in applications needing a special cleaning or in conveyors in which it is not possible to place the motor in the outside due to problems of space or safety.

N° teeth Z	Ø Pitch	Bore for square shaft		Hub width
		mm	inch	
8	52.5	20	3/4	24
16	102.5	40	1.5	40
24	153.5	40 - 60	1.5	40

*Consult the technical department for the availability of split sprocket or machined sprocket with different numbers of teeth.

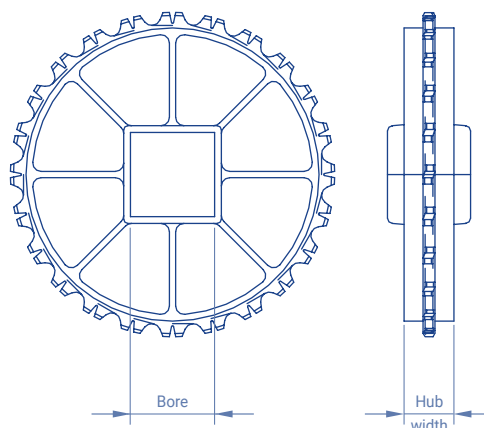

It is manufactured in polypropylene, polyacetal and stainless steel

*check availability in other materials

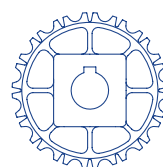

WITH KEYWAY

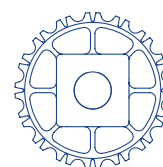

WITHOUT KEYWAY

Accessories **E20** Flights, Side guards and Fingers

Accessories	Height (h)	Materials
Straight flight (Streamline + no cling)	25	Polypropylene Polyethylene Acetal
	50	
Side guards	50	Polypropylene Polyethylene Acetal
Finger plates	-	Nylon Acetal

