

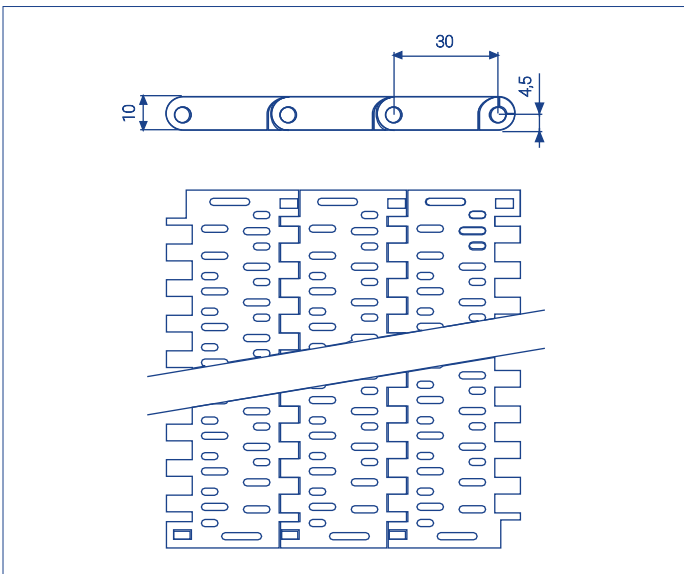





Series E30 Perforated Flat Top



	Belt pitch	30 mm
	Belt width	Multiples of 10 mm
	Rod diameter	4,6 mm
	Drive system	Central
	Ø min direct rotation roller	45 mm
	Ø min reverse rotation roller	100 mm



With an intermediate pitch of 30 mm., is specially indicated for conveying and elevating small-medium product size, being one of the most standar belt of the market.

The traction is made in the central part of the modules, so that it can be used as a bi-directional belt.

Its extraordinary adaptability, combined with its great resistance, allows reaching important conveyor lengths.

Belt surface	Belt material	Rod material	Belt resistance (kg/m)	Belt weight (kg/m ²)	Temperature limit (C°)	Standard Colours ¹	Open Area + opening dimensions	Belt thickness	Retention system
Perforated Flat Top	PP-Polypropylene	PP-Polypropylene	1000	5,01	+1 to +104	W - B	17% [8 x 2] - [5 x 2] mm	10 mm	Cap
	PE-Polyethylene	PE-Polyethylene	600	5,20	-50 to +65	B			
	POM -Acetal	PP-Polypropylene	2250	7,33	+1 to +90	B			
		PE-Polyethylene	1920	7,36	-40 to +65	B			

¹W = White G = Grey N = Natural B = Blue O = Black

Accessories E30 Sprockets

We also have sprockets to be used with motor drum in applications needing a special cleaning or in conveyors in which it is not possible to place the motor in the outside due to problems of space or safety.

N° teeth Z	Ø Pitch	Bore for square shaft		Hub width
		mm	inch	
6	60	25	-	24
9	87,70	25 - 40	1 - 1,5	24
11	106,50	40	1,5	40
14	134,82	40	1,5	40
16	153,50	40 - 60	1,5 - 2,5	40
18	172,76	40 - 60	1,5 - 2,5	40
20	191,50	40 - 60 - 90	1,5	40

*Consult the technical department for the availability of split sprocket or machined sprocket with different numbers of teeth.

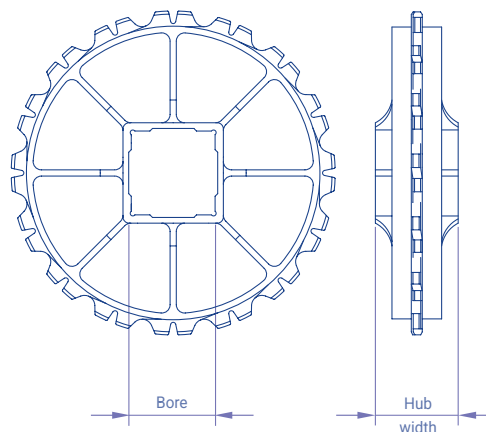

It is manufactured in polypropilene, polyacetal and stainless steel

*check availability in other materials

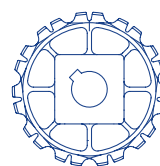

WITH KEYWAY

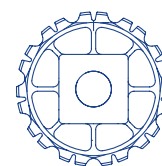

WITHOUT KEYWAY

Accessories E30 Flights, Side guards and Fingers

Accessories	Height (h)	Materials
Straight flight (Streamline + no cling)	25 50 75	Polypropylene Polyethylene Acetal
Straight flight (no cling)	25 50	Polypropylene Polyethylene
Bent flight	45 70	Polypropylene Polyethylene Acetal
Grooved flight	50	Acetal TPC
Flush grid flight	50	Polypropylene Polyethylene Acetal
Side guards	50	Polypropylene Polyethylene Acetal
Specific finger plate Raised Rib	-	Acetal
Finger plate	-	Nylon Acetal

