

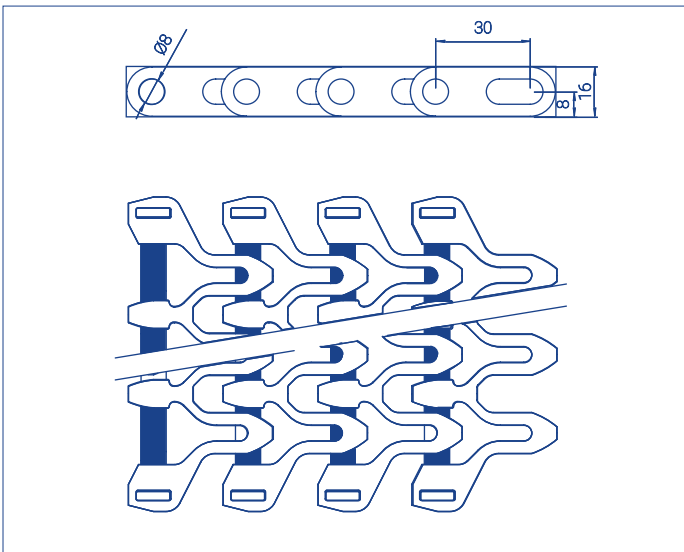





Series E930 Flush Grid without tab



	Belt pitch	30 mm
	Belt width	Multiples of 25 mm
	Rod diameter	8 mm
	Drive system	Hinge
	Ø min direct rotation roller	40 mm
	Ø min reverse rotation roller	150 mm

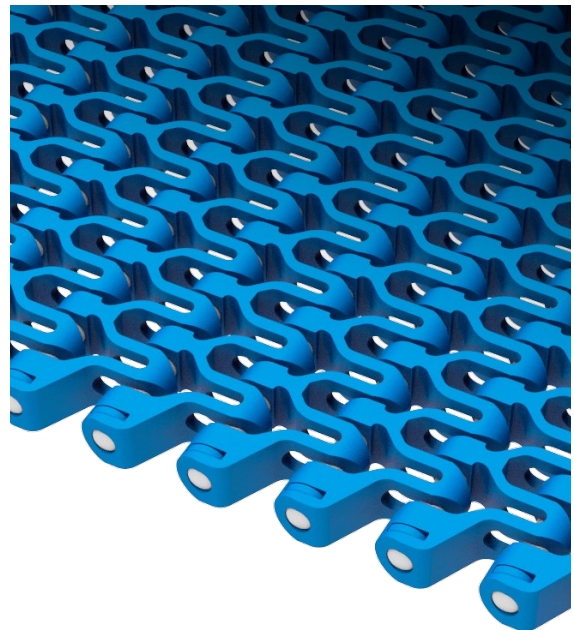

This series is designed to be able to work simultaneously in straight and curved conveyors.

With a pitch of 30 mm and an open surface of 47%, they make it ideal for all types of applications that require large drainage or air flow passage through, such as cooling lines.

With a clamping rod diameter of 8 mm and a locking clip retention, it ensures smooth operation under high loads.

Belt surface	Belt material	Rod material	Belt resistance (kg/m)		Belt weight (kg/m ²)	Temperature limit (C°)	Standard Colours ¹	Open Area + opening dimensions	Belt thickness	Retention system
			Straight	Curve						
Flush Grid without tab	PP- Polypropylene	POM - Acetal	2400	Consult	7,14	+1 to +90	W - G - B	47% Maximum [22 x 5] mm	16 mm	Clip
	POM - Acetal		3800	Consult	9,80	-40 to +90	B - N			

¹W = White G = Grey N = Natural B = Blue O = Black

Accessories **E930** Sprockets

We also have sprockets to be used with motor drum in applications needing a special cleaning or in conveyors in which it is not possible to place the motor in the outside due to problems of space or safety.

N° teeth Z	Ø Pitch	Bore for square shaft		Hub width
		mm	inch	
11	106,5	40	1,5	25
16	153,5	40-60	1,5	25
20	191,5	40-60	1,5	25

*Consult the technical department for the availability of split sprocket or machined sprocket with different numbers of teeth.

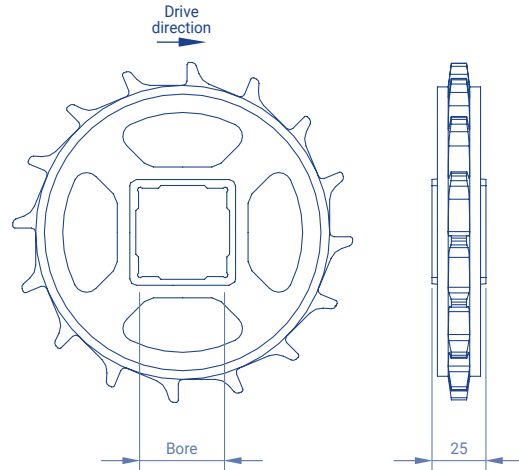

It is manufactured in polypropylene, polyacetal and stainless steel

*check availability in other materials

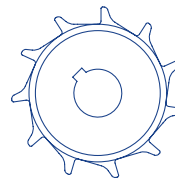

WITH KEYWAY

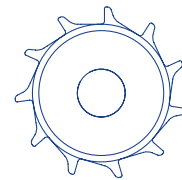

WITHOUT KEYWAY

Accessories **E930** Hold-down profiles and Flights

Accessories	Dimensions	Materials
Profiles in L	40 x 20 x 2000	Polyethylene
Profiles in U	20 x 14 x 2000	Polyethylene
Straight flight (streamline + no cling)	Height (h) 25 - 50	Polypropylene Acetal

